

PHOTOGRAPHIC INTERPRETATION REPORT

KYSHTYM ATOMIC ENERGY COMPLEX, USSR



CIA



DIA

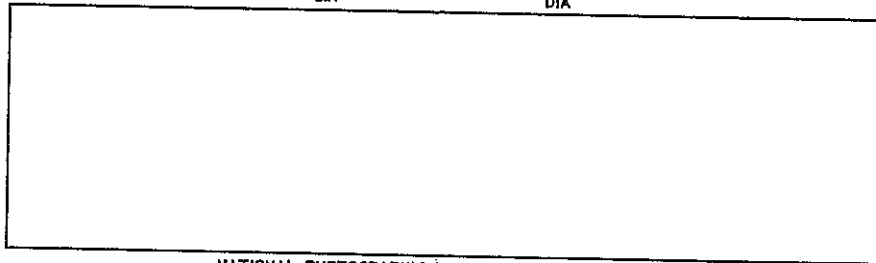

NATIONAL PHOTOGRAPHIC INTERPRETATION CENTER

Declass Review by
NIMA/DOD

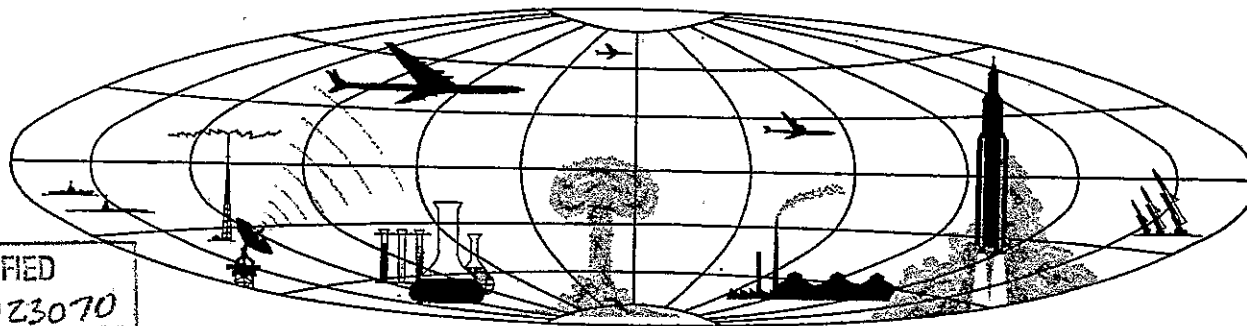

DECLASSIFIED
Authority ND023070
By LTC NARA Date 11/18/03

GROUP 1
Excluded from automatic
downgrading and declassification

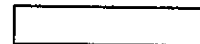

PHOTOGRAPHIC INTERPRETATION REPORT

KYSHTYM ATOMIC ENERGY COMPLEX, USSR



25X1

NPIC/R-568/64
July 1964

NATIONAL PHOTOGRAPHIC INTERPRETATION CENTER



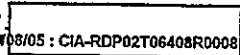

TABLE OF CONTENTS

	Page
INTRODUCTION	1
REACTOR AREA I	1
Reactor Buildings and Related Structures	1
Chemical Separation Plant	1
Steam Supply	1
Water Supply and Circulation	2
REACTOR AREA II	2
Reactor Buildings and Related Structures	3
Steam Supply	4
Water Supply and Circulation	4
Other Facilities	5
REACTOR AREA III	5
Earth Mound and Related Structures	6
Water and Steam	7
CHEMICAL PROCESSING AREA	11
Chemical Separation Plant No 1	11
Chemical Separation Plant No 2	11
Chemical Separation Plant No 3	11
Chemical Separation Plant No 4	11
Tank Facility	11
Unidentified Facility	11
Probable Waste Disposal Plant	11
Steam and Water	11
TATYSH PRODUCTION AREA	14
Facility A	14
Facility B	14
Facility C	15
WATER TREATMENT FACILITIES	17
ELECTRIC POWER	17
REFERENCES	21
APPENDIX A	22



LIST OF ILLUSTRATIONS

	Page
Figure 1. Photo of Kyshtym Atomic Energy Complex facing	1
Figure 2. Location Map	1
Figure 3. Photo of Reactor Area I	2
Figure 4. Layout of Reactor Area I	3
Figure 5. Photo of Reactor Area II	4
Figure 6. Layout of Reactor Area II	5
Figure 7. Photo of Reactor Area III	6
Figure 8. Layout of Reactor Area III	7
Figure 9. Perspective Drawing of Reactor Area III	8
Figure 10. Photo of Chemical Processing Area	9
Figure 11. Layout of Chemical Processing Area	10
Figure 12. Photo of Tatysh Production Area	14
Figure 13. Layout of Tatysh Production Area	15
Figure 14. Photo of Administration and Service Area	16
Figure 15. Perspective Drawing of Eastern Portion of the Administration and Service Area	16
Figure 16. Photo of Pumping Station Y, Main Production Area	16
Figure 17. Photo of Pumping Station Z, Main Production Area	16
Figure 18. Diagram of Power Circuitry Serving the Kyshtym Atomic Energy Complex	17
Figure 19. Layout of Power Circuits Serving the Main Production Area	19
Figure 20. Layout of Water, Steam, and Transportation Facilities in the Main Production Area	20



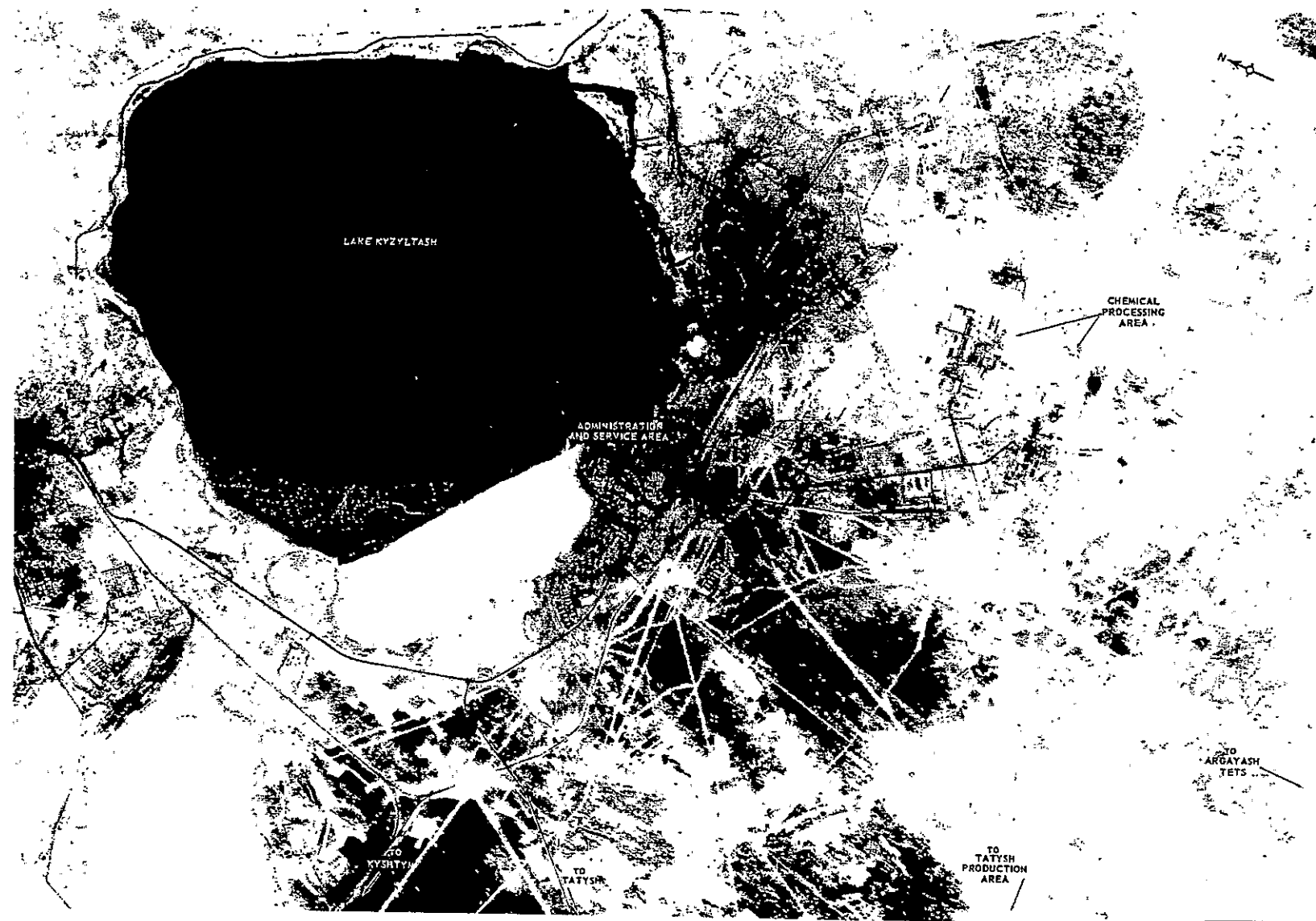

FIGURE 1. KYSHTYM ATOMIC ENERGY COMPLEX.

~~SECRET~~

25X1
25X1

INTRODUCTION

This report updates [redacted] information on the Kyshtym Atomic Energy Complex 1/ and is based on all previous [redacted] photography of the complex and on excellent photography of [redacted] (Figures 1 and 2). The [redacted] photography in particular permitted an extensive refinement of building details and configuration and a detailed reevaluation of electric power circuitry. Except where noted, changes and new identifications described in this report were made possible by the improved quality of the [redacted] photography rather than by actual changes on the ground. At that time the complex was covered by light snow which had drifted in some parts of the complex; the snow was heavier over the eastern portion of the complex and quite light in the vicinity of the Administration and Service Area. Measurements based on the [redacted] photography cannot be included in this report because of mensuration problems which are currently being resolved.

REACTOR AREA I

A newly identified inner wire fence parallels the existing solid fence which surrounds Reactor Area I (Figures 3 and 4). The solid fence is probably a wire fence interlaced with boards or a board fence. Guard towers are situated in at least four corners of the area. The existence of one of the previously reported possible rail spurs serving the southern portion of the area has been confirmed, and two newly observed rail spurs serve the cross-shaped building connected to Reactor Building I-B. Building numbers are keyed to Figure 4.

Reactor Buildings and Related Structures. No major changes were observed in the configurations of Reactor Buildings 1-A and 1-B and related structures. Previously described as rectangular, the fan-house east of Reactor Building 1-B is actually octagonal and is connected to the reactor building by an overhead pipeline or gallery. An overhead pipeline/gallery now extends from building 11 to the overhead pipeline/gallery connecting building 10 and Reactor Building 1-A. A small rectangular building south of building 10 is connected to that building by an overhead pipeline.

All usable [redacted] photography of this reactor area was analyzed in an attempt to determine the ages of the buildings in the area (Figure 4 and Table 1). (No usable photography of the area exists prior to [redacted] Scarring observed southeast of Reactor Building 1-A in [redacted] indicated that the building had been completed only a short time. Since the cross-shaped building (building 15) connected to Reactor Building 1B was not clearly discernible in [redacted] it was either not there or was under construction.

Chemical Separation Plant. No significant changes were discernible in the Chemical Separation Plant in the southern portion of Reactor Area I. A second overhead pipeline now connects building 22 with the canyon building (building 23), and overhead pipelines now connect the canyon building, building 24, and building 26. A rectangular building east of building 25 and a tank near the southern corner of building 26 were observed for the first time.

Steam Supply. Reactor Area I is supplied with steam by the Argayash Thermal Electric Power Plant (Argayash TETS) and/or the Techa steamplant through the

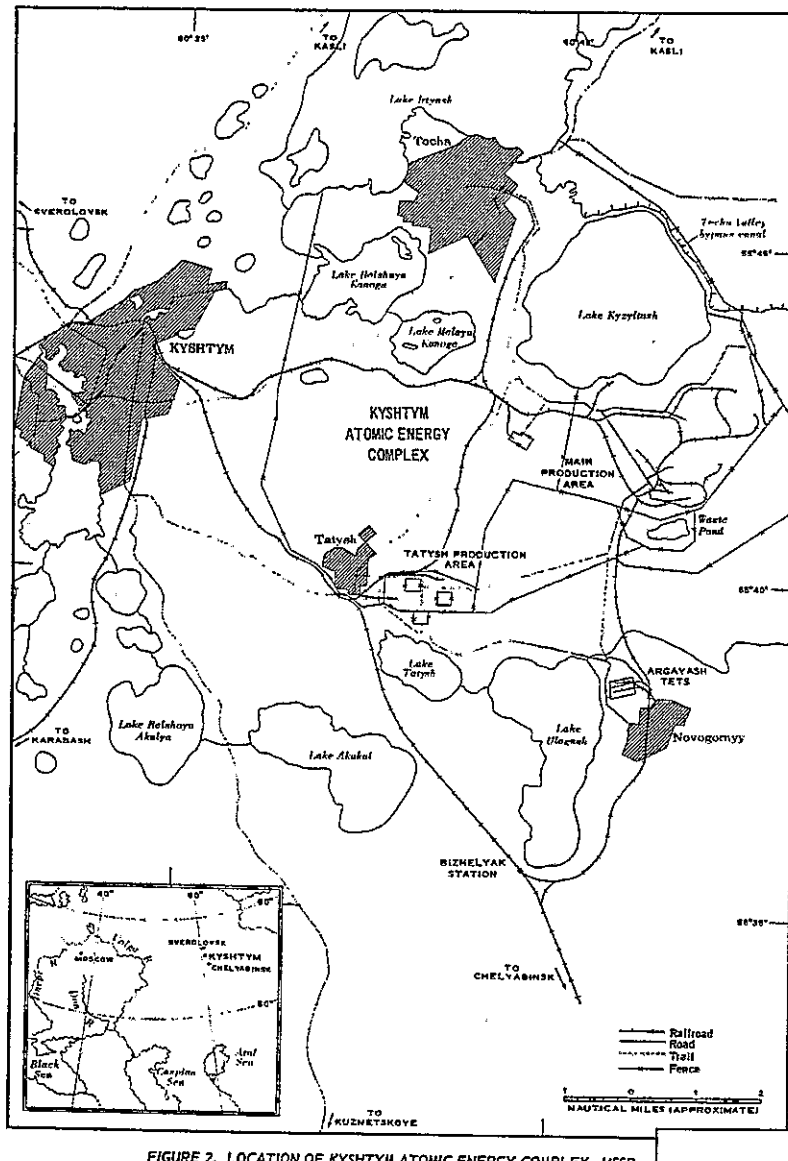

FIGURE 2. LOCATION OF KYSHTYM ATOMIC ENERGY COMPLEX, USSR.



FIGURE 3. REACTOR AREA I

principal steam supply/control valve building west of the Chemical Processing Area and a control valve building west of the probable old construction camp. It also is supplied with steam by the steamplant in the Administration and Service Area on the southern shore of Lake Kyzyltash. These steamlines pass through three probable control valve buildings in or near Reactor Area I. The steamline previously observed southwest of the area can be traced to the vicinity of building 7 where a portion of this steamline is under construction south of that building. A branch of the steamline from the steam supply/control valve building west of the Chemical Processing Area roughly parallels the eastern perimeter fence and terminates at building 2 in the new water treatment plant.

Water Supply and Circulation. Positive identification of buried cold water pipelines serving Reactor Area I was either difficult or impossible because of snow cover on the [redacted] photography. Two possible pipelines from Pumping Station W serve the old water treatment plant (building 4) and two from Pumping Station X serve the new water treatment building. However, complete identification of alignments is not possible. A new trench containing a probable pipeline extending from the vicinity of Pumping Station X was visible north of the old water treatment plant. Hot water carried through one pipeline near the northeast corner of Reactor Area I is discharged at three points near the northwest corner of Reactor Area II (Figure 20).

REACTOR AREA II

In addition to the previously existing solid fence (probably a wire fence inter-

25X1

25X1

25X1
25X1

Approved For Release 2003/08/05 : CIA-RDP02T06408R000800010080-4

Table 1. Construction Progress of Buildings in and near Reactor Area I (Building numbers are keyed to Figure 4)

Blkg	Construction Status	Construction Status
1-A	Completed	Completed
1-B	Completed	Completed
1	Not observed	Under construction; foundations in
2	Under construction; foundations in	Under construction; walls probably in
2	Completed	Completed
4	Completed*	Completed
5	Completed*	Completed
6	Observed; construction status indeterminate**	Observed; construction status indeterminate**
7	Construction status indeterminate**	Completed
8	Completed*	Completed*
9	Completed*	Completed*
10	Construction status indeterminate**	Completed*
11	Completed*	Completed*
12	Construction status indeterminate**	Completed*
13	Completed	Completed
14	Completed*	Completed
15	Probably under construction	Completed
16	Not observed	Possibly under construction
17	Not observed	Not observed
18	Not observed	Possibly under construction
19	Not observed	Completed
20	Under construction	Completed
21	Completed	Completed
22	Completed	Completed
23	Completed	Completed
24	Completed*	Completed
25	Completed	Completed
26	Completed*	Completed

*Change in configuration was determined from the photography.
 **Not previously reported, but reanalysis of this photography indicates it may have existed.

placed with boards or a board fence), Reactor Area II is now enclosed by a newly identified inner wire fence (Figures 5 and 6). The area is divided into two sections by a probable wall which extends from a guardhouse at the main entrance to a possible pumphouse at the eastern perimeter fence. Security precautions for the southern half of the area now include two guardhouses at the main entrance to the area and at least three guard towers; a new L-shaped guardhouse for the northern half of the area is located west of the T-shaped administration building just outside the main entrance to the reactor area.

Reactor Buildings and Related Structures. A suspect rail spur was observed north of Reactor Building II-A. Reactor Building II-B is connected to a rectangular

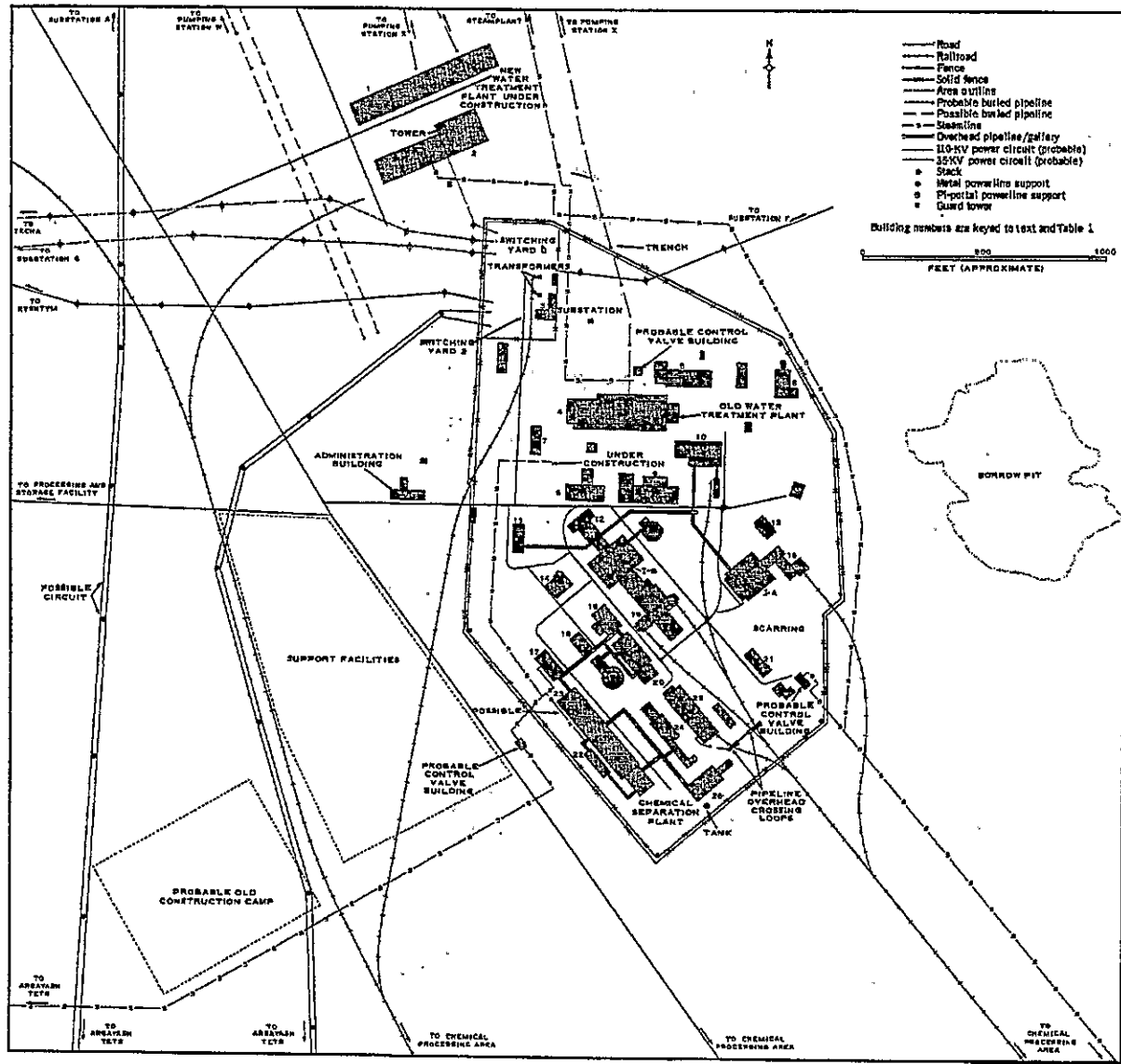

FIGURE 4. REACTOR AREA I.

25X1

25X1

25X1

25X1

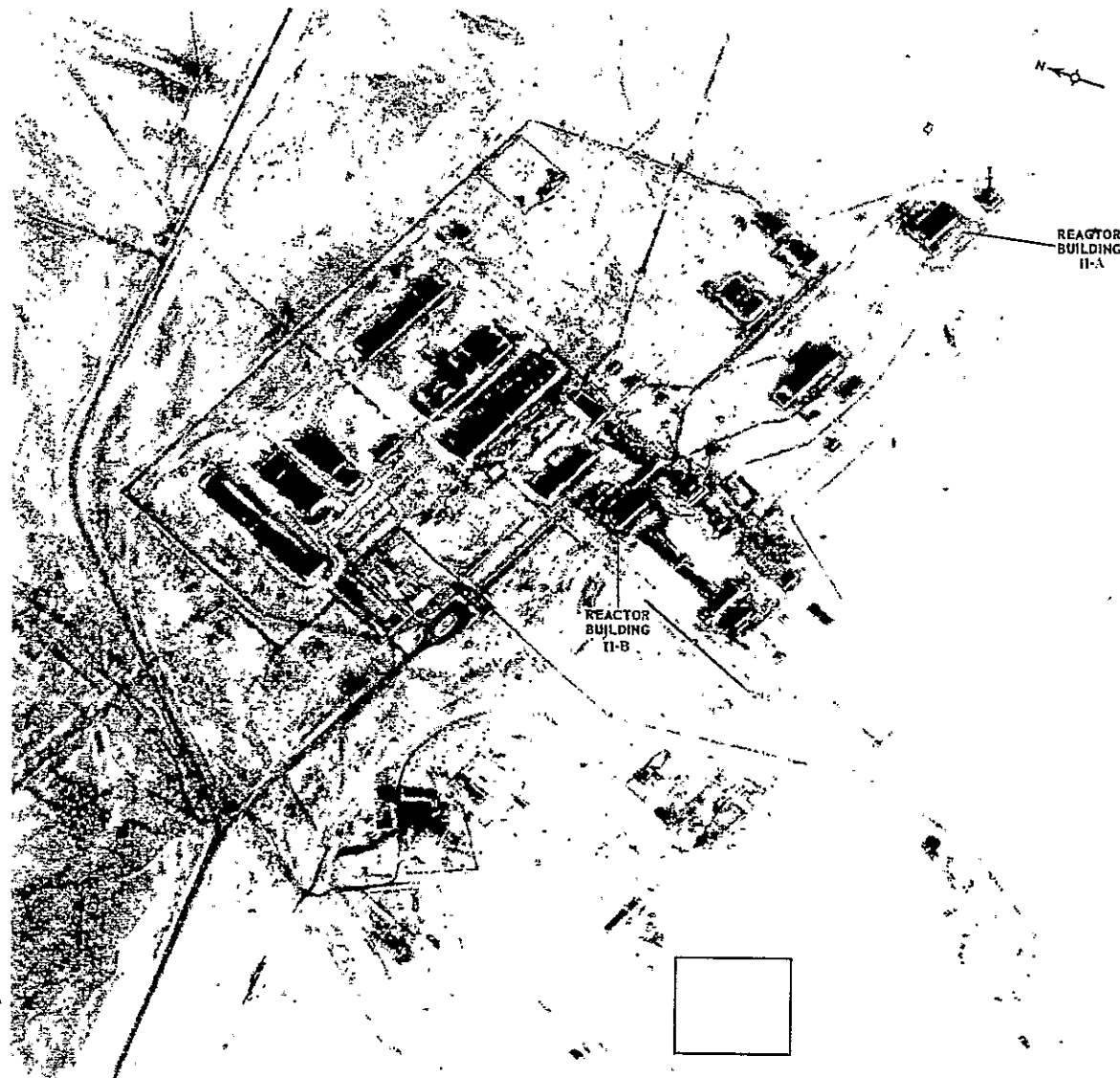

building by an overhead pipe gallery now known to have existed in [redacted] and an excavation was visible west of this reactor building. The fanhouse for this reactor building is larger than previously reported and a projection on the north side of the building is similar to the one observed at the fanhouse for Reactor Building I-B in Reactor Area I. An abandoned solid security fence extending from the vicinity of this fanhouse to the fanhouse for Reactor Building II-A was visible for the first time. The cross-shaped building connected to Reactor Building II-B is now served by three rail sidings, one at the south end of the building and one at each end of the crossbar. In [redacted] a steam locomotive and three freight cars were standing on the siding at the west end of the crossbar. A new road, three new buildings, and a foundation and column footings for a fourth were observed east of the building. In the northern half of the area circular ground scarring at the west end of a building near the northern perimeter fence may indicate the presence of two buried tanks. The rail spur in the northwest corner of the area is now seen to terminate inside substation F.

25X1

25X1

Steam Supply. Reactor Area II receives steam through steamlines from the steamplant in the Administration and Service Area and from the steam supply/control valve building west of the Chemical Processing Area. These steamlines terminate at a control valve building southwest of the possible water treatment building. A steamline also connects Reactor Areas II and III.

Water Supply and Circulation. Two probable buried pipelines from Pumping Station X and three from Pumping Station Y supply water to Reactor Area II. All five pipelines probably terminate at the water purification building. A possible

FIGURE 5. REACTOR AREA II [redacted]

25X1

25X1

25X1

25X1

buried pipeline is visible just outside the northwest corner of the reactor area and parallels a portion of the perimeter fence at that point. A probable buried hot water pipeline observed west of the possible water treatment building extends through the perimeter fence in a northeasterly direction. It is not clear how hot water is discharged into the two effluent channels at the west end of the hot water channel; hot water may come from either Reactor Area I or II.

Other Facilities. The existence of the possible waste burial ground southwest of Reactor Area II has been confirmed; it contains one building and four semiburied earth-covered tanks. Four areas, two of which are separately secured by solid fences, are situated in the immediate vicinity of the burial ground. Three of these areas contain buildings, construction sheds, and stored materials. An unidentified fenced activity previously reported as a building is situated southeast of the reactor area. 1/ Six buildings and two cranes, which are probably mobile, were observed in a rail yard and storage area southwest of the reactor area.

REACTOR AREA III

Although the [redacted] photography of Reactor Area III is excellent, it does not provide sufficient evidence to determine the operational status of the area (Figures 7-9). The road turnaround just outside the main entrance has been cleared of snow and showed signs of heavy traffic. However, the main gate was closed, and snow had drifted against it. Some stretches of road inside the area were not snow covered, but whether the snow had been removed by plows or by wind could not be positively determined

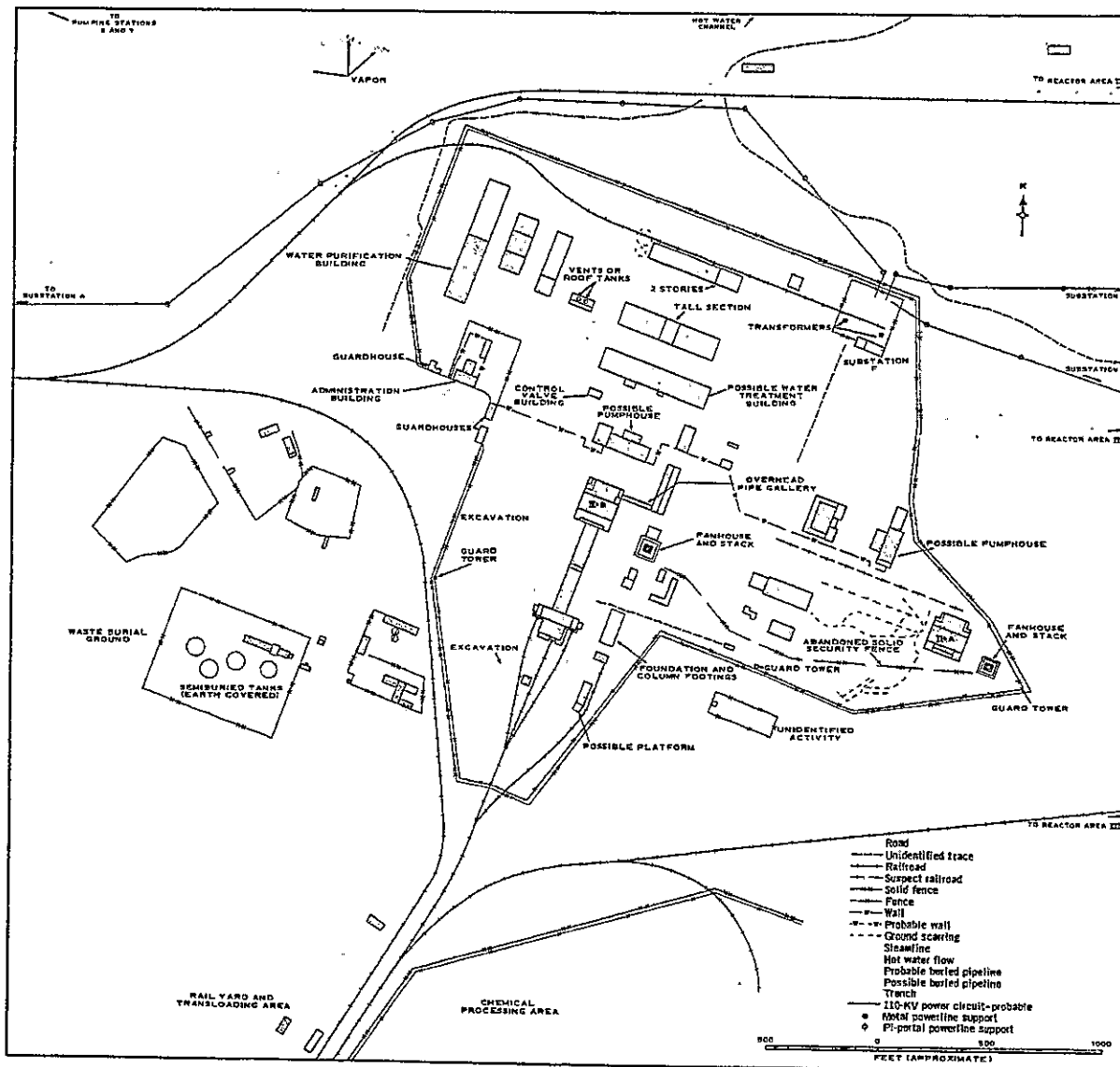

FIGURE 6. REACTOR AREA II.

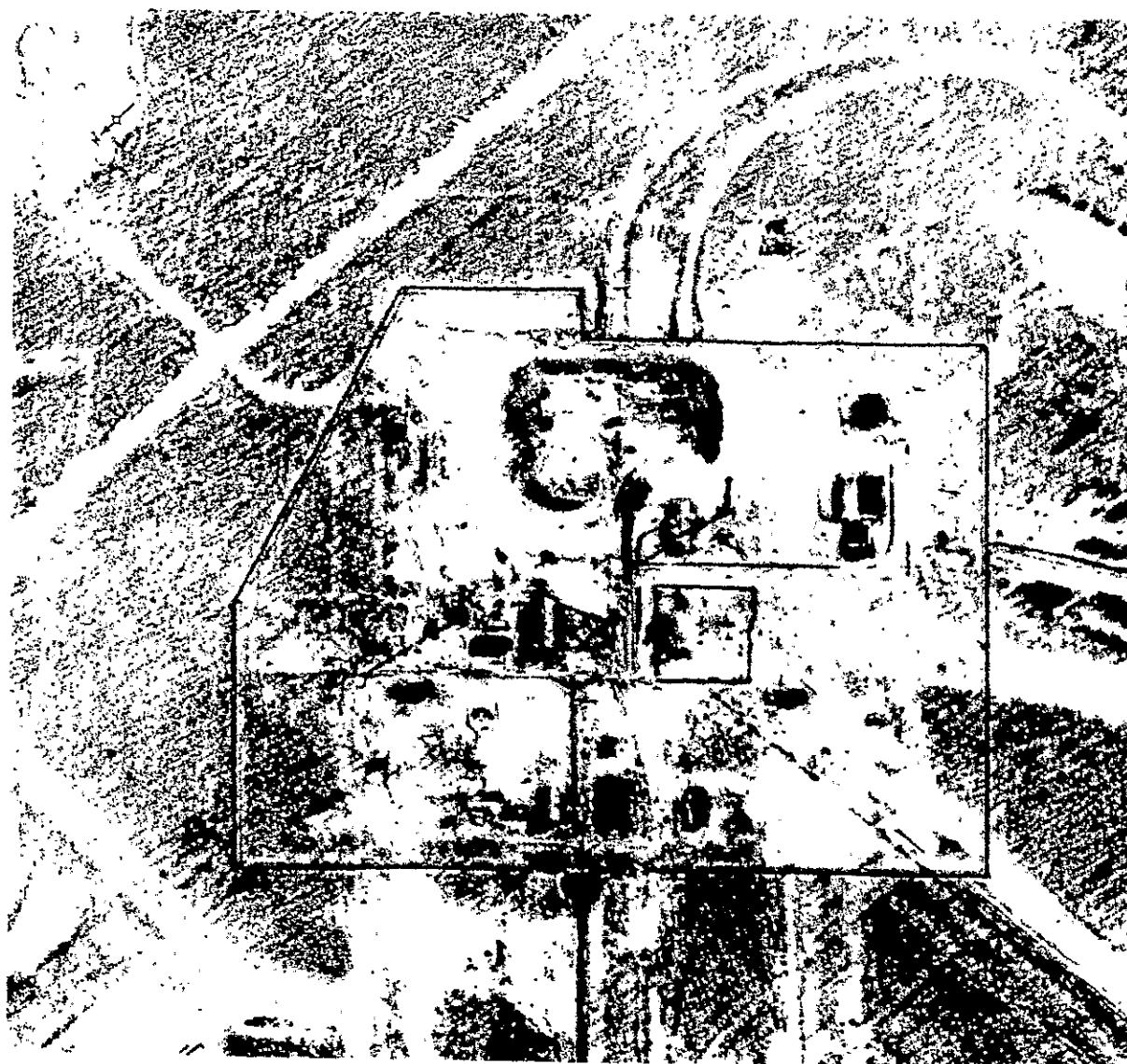

FIGURE 7. REACTOR AREA III, [REDACTED]

from the photography. Most roofs in the area were snow free, and some snow had drifted against roof parapets. All railroad tracks serving the area were snow covered. A double security fence similar to that surrounding Reactor Areas I and II encloses Reactor Area III. Guardhouses were visible on both sides of the road at the main entrance, and guard towers are situated at strategic points along the perimeter fence.

Earth Mound and Related Structures.

There has been little change in the configuration of the mound since it was first observed in [REDACTED]. Since few signs of erosion were evident in [REDACTED] and since the western slope of the mound is very steep, it is possible that the mound originally consisted of a mixture of concrete and earth which provided additional shielding against radiation. Newly observed details of the configuration of the mound and its immediate vicinity may indicate that a large structure is buried under the mound and that portions of the structure are below ground level and probably extend beyond the periphery of the mound (Figure 8). The buried structure may be divided functionally into two portions, one on each side of the underground through rail line. The second underground rail line probably terminates inside the mound. Identical features associated with each portion of the underground structure suggest that each portion of this structure may house a reactor. These features include the following: two tall stacks, one north of the mound and the other, west of it, and both having octagonal bases rather than round bases as previously reported; 1/ two irregularly shaped configurations resembling concrete slabs situated at ground level or slightly below ground level and each having two possible vents or skylights; two possible centrifugal ex-

25X1
25X1

25X1

haust fans; and two possible air intakes. At least seven additional small possible vents also project above the surface of the mound.

In addition to several newly observed buildings, a semiburied tank west of the mound and a possible buried tank north of the mound were also identified. A possible buried flue extends from the northern stack to a small building north of the mound. Substation E is secured by a solid fence and served by a rail spur. In [redacted] four snow-covered freight cars were visible at one of the underground railroad entrances just outside the southeast perimeter fence. No other significant changes were noted in the area.

Water and Steam. Water is, or was, supplied to Reactor Area III from Pumping Station Z on the southeastern shore of Lake Kyzyltash. An accumulation of snow on the roof of this station indicates that it was probably not in use in [redacted]. Although the rough broken nature of the terrain northwest of the area made it difficult to identify and trace all pipelines between this pumping station and the reactor area, four probable buried pipelines were observed. In the eastern section of the area two probable buried pipelines were observed for the first time, one terminating southeast of the area and the other, just outside the eastern perimeter fence. No melted snow from hot water pipelines was evident between Reactor Area III and a discharge point near Pumping Station Z. A new steamline and three probable buried pipelines from Reactor Area II enter the western corner of Reactor Area III. The exact terminus of the steamline inside the area cannot be determined from the photography. Two probable buried pipelines extend from the southwest corner of the area to the vicinity of the Chemical Processing Area.

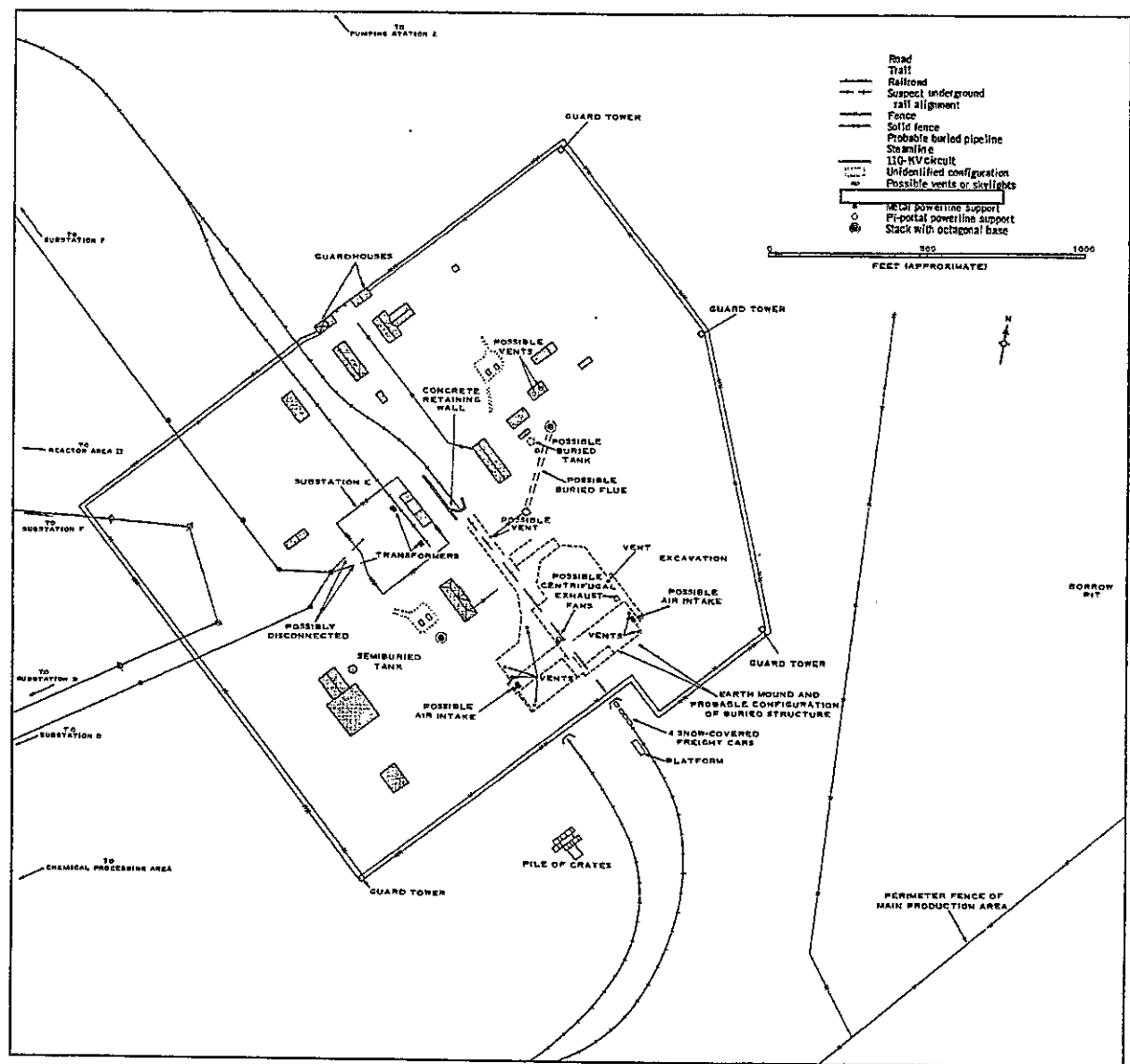

FIGURE 8. REACTOR AREA III.

25X1

25X1

25X1

25X1

25X1

25X1

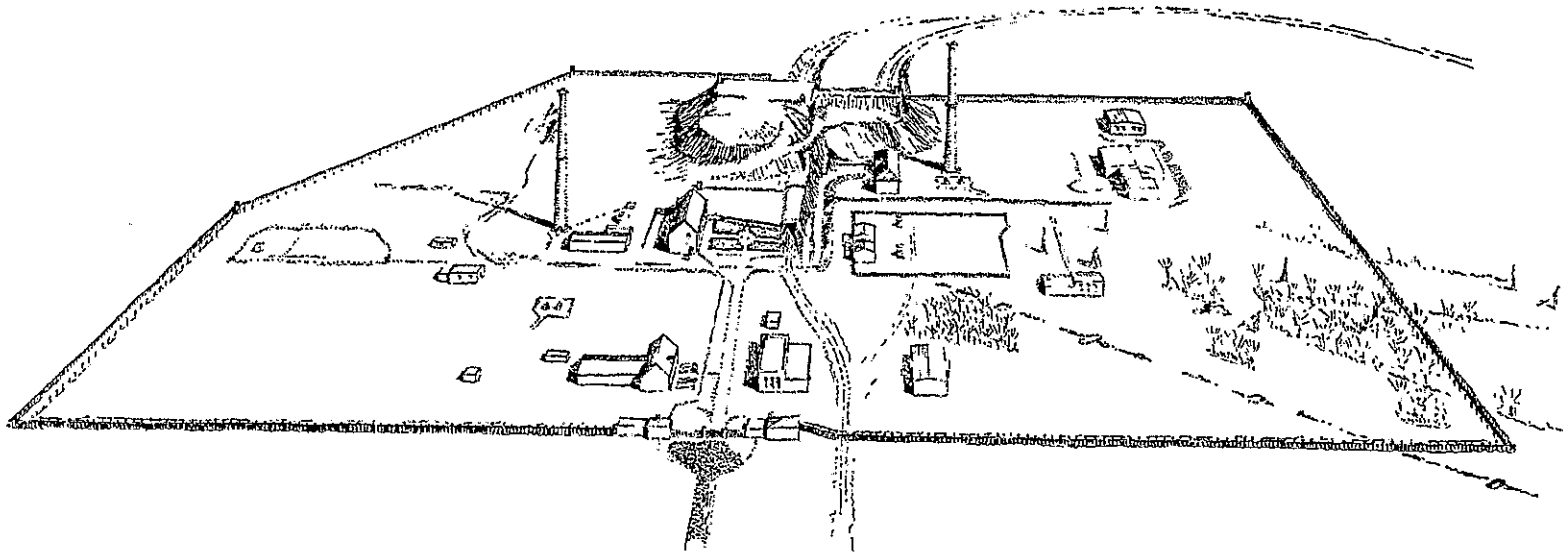
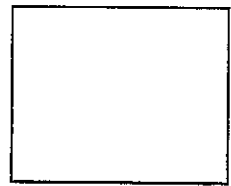

FIGURE 9. PERSPECTIVE OF REACTOR AREA III.





FIGURE 10. CHEMICAL PROCESSING AREA, [redacted]



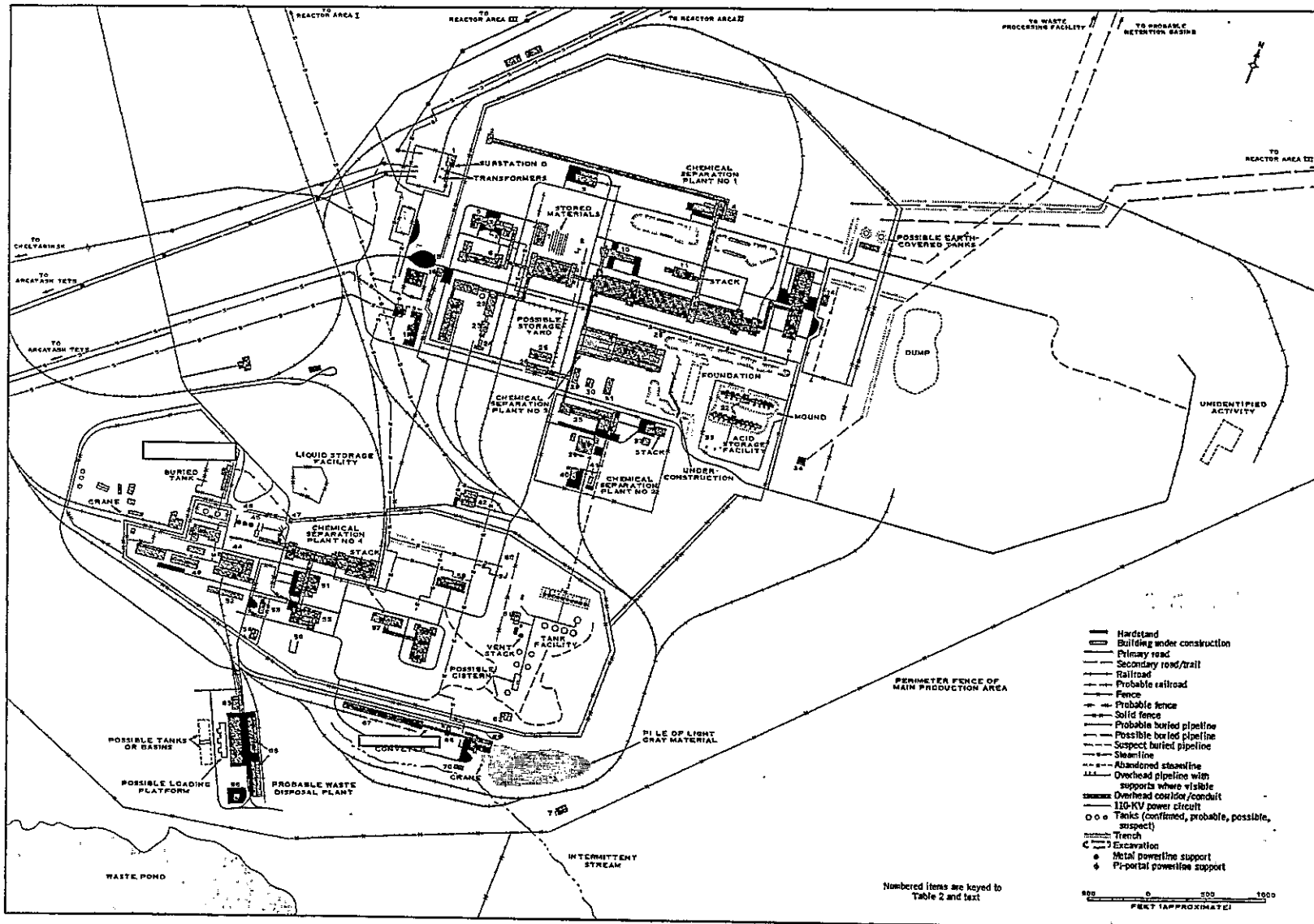

FIGURE 11. CHEMICAL PROCESSING AREA.

25X1

25X1

25X1

25X1

CHEMICAL PROCESSING AREA

Two security fences similar to those observed at the three reactor areas not only surround most of the Chemical Processing Area but also separately secure the southern portion of the area (Figures 10 and 11). In addition to the three previously reported chemical separation plants, 1/ a fourth chemical separation plant has been identified in the southern portion of the area. Whether or not there is a tritium plant in the southern half of the area cannot be determined from the photography at this time. Building numbers are keyed to Figure 11 and Table 2.

Chemical Separation Plant No 1. In [redacted] piles of stored materials north of a processing building (building 9) were reported as an unidentified building under construction. 1/ Scarring for the possible buried pipeline south of the canyon building (building 12) has been covered by landscaping and is no longer visible. The [redacted] photography revealed that before construction on the second canyon building had stopped, some concrete for foundation walls had been poured in the excavation north of building 12. What is actually a supporting structure for an overhead corridor and/or conduit between buildings 12 and 13 was previously described as a loading/unloading building. 1/

Chemical Separation Plant No 2. No significant changes were noted in Chemical Separation Plant No 2. The [redacted] photography revealed that the previously

reported chemical processing building (building 35) and a product receiving building at the west end of building 35 are actually one building. 1/ The suspect buried pipeline extending from building 35 to the Tank Facility was snow covered.

Chemical Separation Plant No 3. Construction continues on this plant and about half of the chemical processing building (building 27) has been roofed. A new L-shaped excavation and a trench were observed southeast of building 27. Two parallel overhead pipelines under construction and a rectangular foundation were visible east of the chemical processing building. A long narrow excavation northeast of this building has been dug since [redacted]. The suspect pipeline between buildings 29 and 30 was snow covered in [redacted].

Chemical Separation Plant No 4. The [redacted] photography made it possible to identify a fourth chemical separation plant in the southern portion of the Chemical Processing Area. Building 48 has been identified as a chemical separation building. What was previously reported as one probable processing building 1/ is actually two buildings (buildings 44 and 45) connected by an overhead corridor and/or conduit and to building 48 by a similar overhead corridor and/or conduit. These buildings measure 350 by 65 feet (overall) and 210 by 50 feet, respectively. A gatehouse (building 46) is situated northwest

of building 45. An irregularly shaped separately secured compound has been identified southeast of buildings 44 and 45. Previously described as a probable administration or laboratory building and a warehouse-type building, 1/ this compound is road served, and its function is unknown.

Tank Facility. The [redacted] photography indicated that the possible control valve building no longer exists. The five possible tanks (each 50-60 feet in diameter) were snow covered and only the overhead pipe connections were visible. The row of ten probable tanks was also snow covered and only valves and other equipment were visible. Haze over the facility precluded further analysis.



Probable Waste Disposal Plant. This plant located just outside the southern perimeter fence of the Chemical Processing Area and containing buildings 63, 64, 65, and 66 is now served by two new rail sidings which parallel buildings 64 and 65. Building 64 is wider than previously reported, and a possible loading platform west of the building may be connected to it by a ramp. What was formerly reported as a building under construction may be two rectangular tanks or basins.

Steam and Water. The visible network of steamlines leaving the steam supply/control valve building (building 18) includes a steamline which probably serves buildings 57 and 58 in Chemical Separation Plant No 4 rather than terminating at a control valve building (building 47) as previously reported 1/ and a new steamline to the materials processing-type building (building 69) and to the probable locomotive shed and/or car maintenance shop (building 42). A network of steamlines was observed east of a processing building (building 48) and in the vicinity of an unidentified building (building 59). The steamline previously observed east of building 47 is actually a solid fence. In Chemical Separation Plant No 1 a new steamline which parallels the road south of buildings 9 and 12 probably supplies steam to building 5.

In the northeast corner of the area two probable buried pipelines from Reactor Area III, one of which was previously described as a probable steamline, can be traced to the vicinity of two possible earth-covered tanks and a small building. Two possible buried pipelines were observed northeast of the area, one of which extends to either the Waste Processing Facility or to a discharge point on the shore of Lake Kyzyltash and the other, to the probable retention basins in the northeast corner of the Main Production Area.

25X1

25X1

25X1
25X1

Table 2. Data on Buildings in and near the Chemical Processing Area (Building numbers are keyed to Figure 11)

Bldg No	Identification & Description	Bldg No	Identification & Description
1	Control & low-voltage switching bldg for substation D; no change since []	18	Steam supply/control valve bldg; principal control point for steam in Main Production Area
2	Possible control bldg with 1-story covered conduit having an inverted V configuration; possible pipeline on top of conduit; pipeline not snow covered in []	19	Probable admin bldg; no pipeline connection to bldg 20 as previously reported 1/
3	Loading/unloading bldg; open-air loading platform on N side	20	Processing bldg; L-shaped; leg of L higher than rest of bldg; rail served; may be used for loading & unloading freight cars
4	Possible pumping station; previously reported as possible processing bldg; 1/ unusual roof configuration; monitors on roof of main portion; may house a dual pumping system in E & W ends of main section; overhead covered conduit to bldg 12	21	Probable processing bldg; no changes since []
5	Probable lab; high center portion; small rectangular structure near road W of bldg	22	Processing bldg; N end slightly higher than rest of bldg
6	Lab-type bldg; no change since [] small cubical structure N of bldg	23	Processing bldg; low narrow portion at S end
7	Unidentified bldg; rail siding on W face of bldg; may have loading function; 12 freight cars & probable locomotive standing on siding in [] western third in 2 stories high	24	Possible loading bldg; T-shaped; probable short freight car on siding; loading/unloading rail through bldg S of bldg 24 no longer exists
8	Unidentified bldg; previously reported as suspect partially buried tank; 1/ has 2 possible roof vents and/or exhaust fans; stored bldg materials W of bldg formerly described as unidentified bldg under const 1/	25	Probable storage bldg; previously reported as an unidentified bldg in separately secured compound; 1/ dormer ventilators on gable roof
9	Processing bldg; W crossbay over 100 ft high; high narrow structure on wide 1-story center section; 2 tall metal venting stacks with conical bases on roof of center section; conical bases not snow covered in []	26	Probable loading bldg; previously reported as an unidentified bldg in separately secured compound; connected to overhead corridor/conduit systems serving Chemical Separation Plants No 1, 2, & 3 by overhead pipeline
10	Probable processing bldg; previously reported as unidentified bldg; 1/ irregularly shaped; pent-house-type structure on W end	27	Chemical processing bldg under const in Chemical Separation Plant No 3; partially roofed; large room & part of long narrow room visible in W end of bldg; 1 projection near SE corner rather than 2 as previously shown; 1/ 2 large vertical vent shafts under const; possible covered loading/unloading platform on NE side; 2 overhead pipelines under const E of bldg may terminate at E end of bldg when completed
11	Blower bldg with stack; formerly probable; 1/ connected to overhead covered conduit between bldgs 4 and 12 by a power cable or overhead corridor/conduit	28	Probable control valve bldg; situated on newly observed steamline
12	Canyon bldg for Chemical Separation Plant No 1; configuration of longitudinal portions similar to that of bldg 9; has 5 crossbays; westernmost crossbay has irregular configuration; 7, possibly 8, roof vents on W center crossbay; at least 1 roof vent on center crossbay discharging vapor in [] 4 roof vents on E center crossbay	29	Probable admin bldg for const activities; previously reported as an unidentified bldg; 1/ connected to bldg 28 by an overhead corridor/conduit; no longer connected to bldg 30 by suspect overhead pipeline
13	Unidentified bldg; irregular configuration; S portion; resembles longitudinal portions of bldg 12, has tall roof venting stack similar to those on bldg 9, & has no windows on W side; N portion: wide 1st story & narrow 2nd story, has windows on W side; at least 2 vents on high crossbay at N end	30	Construction shack; previously reported as an unidentified bldg 1/
14	Unidentified bldg; no change since [] possible control or processing bldg N of bldg 16 no longer exists; trench N of bldg in []	31	Construction shack; previously reported as an unidentified bldg; 1/ connected to bldg 27 by overhead corridor/conduit
15	Probable security bldg on N side of main entrance; identified in []	32	Acid storage control bldgs (2) in Acid Storage Facility; overhead galleries or roofs cover tanks; bldgs & tanks situated on an earth mound; N bldg & tanks higher than S bldg & tanks; guard-house at N fence line of facility
16	Guardhouse at main entrance; no change since []	33	Unidentified U-shaped bldg in Acid Storage Facility; previously reported as 2 probable terminal tanks; 1/ rectangular tower on W side & square tower on E side; towers connected by 1-story corridor; may be connected to acid storage bldgs by possible buried pipeline
17	Probable security control bldg in a separately secured compound; 2 small service bldgs also in compound	34	Possible control valve bldg; no change since []
		35	Chemical processing bldg for Chemical Separation Plant No 2; W end of bldg previously described as product receiving bldg; 1/ connected to bldg 28 by overhead corridor/conduit

25X1

25X1

25X1

TOP SECRET

25X1
25X1

Table 2. (Continued)

Bldg No	Identification & Description	Bldg No	Identification & Description
36	Fan bldg with venting stack; no change since [redacted]	53	Warehouse-type bldg; previously shown as 2 bldgs; 1/ 1 bldg probably removed
37	Unidentified bldg; no change since [redacted]	54	Unidentified bldg; small L-shaped structure & possible vertical tank NE of bldg
38	Probable final processing & shipping bldg; structure formerly connected to W side no longer visible	55	Probable processing bldg; partially obscured by smoke or vapor from stack on bldg 48; irregular configuration with highest portion having cruciform configuration; no tanks at E end as previously reported; 1/circular roof configuration at SE corner may be a tank or ventilating fan
39	Possible railroad weighing scale bldg; previously reported as possible vertical cylindrical tank on S side of bldg 38; low square structure; purpose of adjacent similar structure unidentified	56	Processing bldg; identified from [redacted] photography; barely discernible on [redacted] photography; high center portion; 2 probable vertical configurations resembling chemical processing equipment on S side; venting stack (at least 100 ft high) with small diameter at SW corner
40	Unidentified bldg; loading platform on E side; wing at NW corner	57	Processing bldg in Chemical Separation Plant No 4; rectangular penthouse at NW corner; probable mechanical equipment on center of bldg
41	Unidentified bldg; no changes since [redacted]	58	Processing bldg in Chemical Separation Plant No 4; tall venting stack & probable mechanical equipment on roof of S end; square structure identified W of bldg in [redacted]
42	Probable locomotive shed and/or car maintenance shop; 2 rail sidings	59	Possible admin bldg; previously reported as an unidentified bldg; 1/hipped roof; 2 newly observed small structures in immediate vicinity
43	Possible tank lab; 2 tanks in fenced compound N of bldg; tanks snow covered in [redacted]	60	Possible steam supply/control valve bldg; L-shaped; identified in [redacted]
44	Probable processing bldg; bldgs 44 & 45 reported as 1 bldg in [redacted] 1/ approximately 9 roof vents on ridge of bldg; connected to bldgs 45 & 48 by overhead corridors/conduits	61	Probable processing bldg in Tank Facility; previously designated as an unidentified bldg; 1/ 4 small structures, 2 or 3 small vertical tanks, a possible buried rectangular tank or cistern, & 1 venting stack in immediate vicinity
45	Probable processing bldg; bldgs 44 & 45 reported as 1 bldg in [redacted] 1/ connected by overhead corridor/conduit to bldg 44; W section of bldg at least 3 stories high; W crossbay is highest part of bldg; 3 tall venting stacks on bldg; E section of bldg has hipped roof	62	Unidentified bldg in Tank Facility; no change since [redacted]
46	Guardhouse at entrance NW of bldg 45	63	Probable liquid waste receiving and/or control bldg in Probable Waste Disposal Plant; overhead pipeline on E side may not be connected to bldg
47	Control valve bldg for possible underground pipeline to Unidentified Facility N of bldg 43; previously reported as probable valve control bldg 1/	64	Probable waste treatment bldg in Probable Waste Disposal Plant; N & S portions same-width (est 80 ft); connected to bldg 50 by overhead pipeline
48	Chemical separation bldg in Chemical Separation Plant No 4; possibly a pilot plant for Chemical Separation Plant No 1; formerly identified as a processing bldg; 1/ 3 roof vents on W cross-bay; longitudinal section has stepped configuration, at least 3 roof vents, & small penthouse; stack discharging vapor or white smoke in [redacted] 2 probable centrifugal roof fans on E end of bldg; 1 flue from main portion of bldg & 2 from probable centrifugal roof fans tied to stack; L-shaped covered loading platform at NE corner; 3 tanks or possibly chemical processing equipment on N side of bldg	65	Possible waste treatment bldgs (2); no change since [redacted]
49	Probable storage bldg; previously described as an L-shaped unidentified bldg; 1/ no tanks on N side of bldg as previously suspected	66	Possible waste discharge control bldg; no change since [redacted]
50	Probable processing bldg; irregular roof configuration; 3 tanks W of bldg	67	Possible storage bldg; may be a thawing bldg for materials processed in bldgs 68 & 69; T-shaped; only 5 roof vents on stem of bldg; possible semiburied conveyor to bldg 68
51	Probable processing bldg; formerly described as an unidentified bldg; 1/ not 2 bldgs as previously suggested; 1/ at least 4 roof ventilators; probably connected to overhead corridor/conduit above roof	68	Conveyor machinery bldg; previously reported as an L-shaped unidentified bldg 1/
52	Processing and/or possible packaging & shipping bldg; 2 large & 2 small tanks SW of bldg; 2 small structures at SE corner	69	Materials processing-type bldg; crane S of bldg in [redacted]
		70	Possible admin or utility bldg; no change since [redacted]
		71	Probable security bldg; no change since [redacted]

25X1
25X1
25X1

25X1
25X1
25X1

25X1

25X1

25X1

25X1

25X1

25X1

25X1
25X1

25X1
25X1
25X1

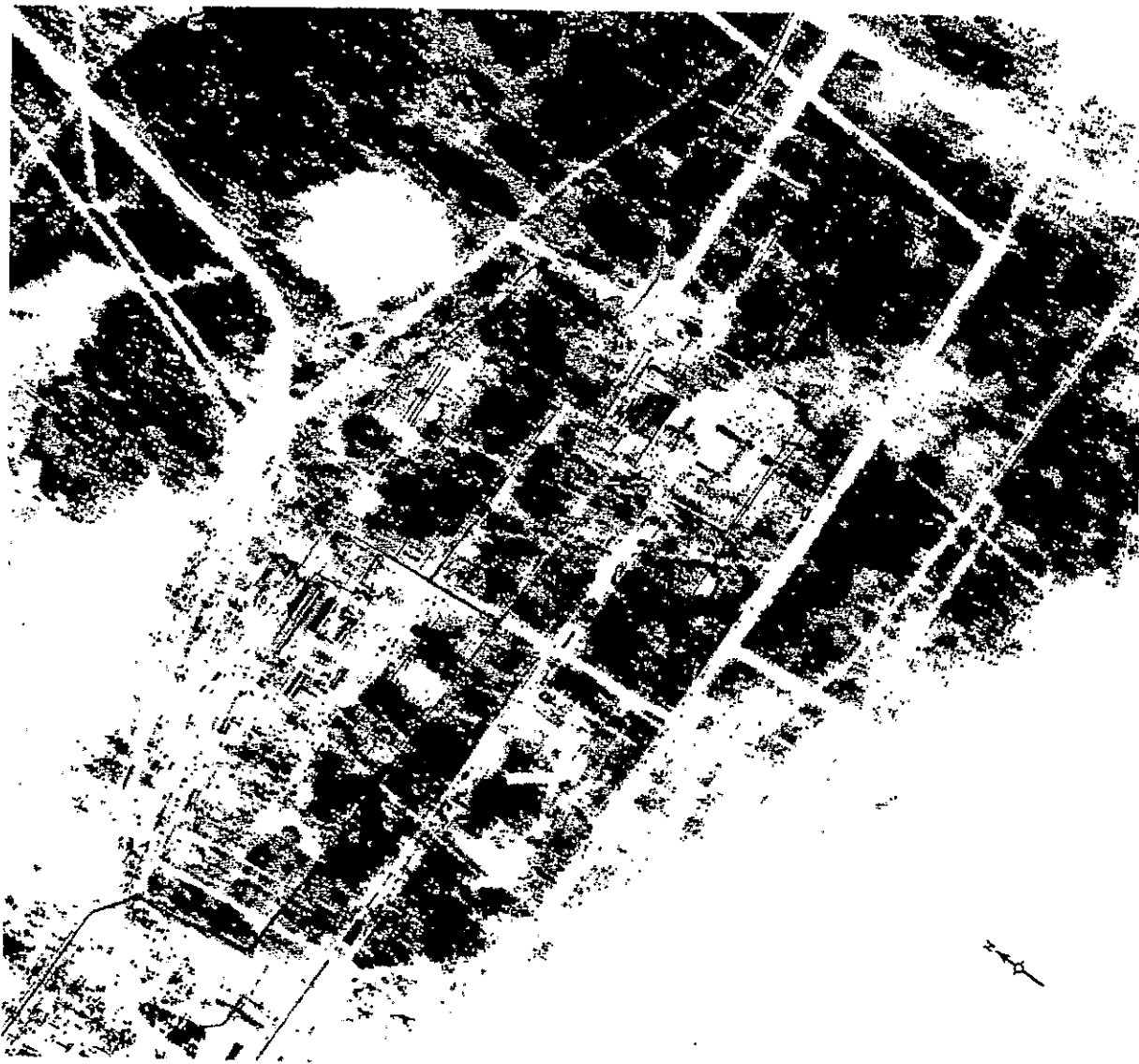

TATYSH PRODUCTION AREA

The [redacted] photography provided details not previously observed, but this photography did not make it possible to determine the processes which may be carried on inside the Tatysh Production Area (Figure 12). In the northern portion of the area, the previously identified possible rail transfer facility 1/ has been identified as a separately secured backup steamplant. In [redacted] the plant was not in operation since no smoke was being discharged from either stack, the snow in the vicinity of the plant was white, and the coal-handling and unloading equipment had not been used. At the transloading point, a rail spur and a building connected to a rail unloading trestle by [redacted] [redacted] conveyer were observed for the first time. The Tatysh Production Area is supplied with steam through a steamline extending from the Main Control and Distribution Point southwest of the Main Production Area to a control valve building in the northeast corner of the area. This building existed in [redacted] but was not identified at that time. Building numbers are keyed to Figure 13.

Facility A. Facility A is almost completely surrounded by a solid fence, and two guard posts were discernible. One of the probable laboratory/processing-type buildings (building 1) is still under construction, and interior and exterior walls were visible. Work has not started on the roof, and construction materials were stacked along the north side of this building. A laboratory-type building (building 6) is T-shaped rather than rectangular, 1/ and a stack is connected to the stem of the "T" by a horizontal flue. The stack for building 5 is on the east side of the building

FIGURE 12. TATYSH PRODUCTION AREA, [redacted]

25X1

25X1

25X1

25X1

25X1

25X1

25X1

rather than near the southwest corner as previously reported. 1/ A system of overhead pipelines connecting a transloading building and building 1 is probably tied into the control and low-voltage switching building (building 2) in substation C-1. Overhead pipelines also interconnect buildings 2, 4, and 5. A new well traveled road serves the southern portion of Facility A and extends to a probable warehouse in the southwestern section of the production area. The T-shaped building east of the facility has been separately fenced.

Facility B. This facility has been enclosed by a solid fence, and two guardhouses (buildings 12 and 13) are located at the main entrance. Two venting stacks were observed for the first time, one east of the processing-type building (building 9) and connected to that building by an overhead horizontal flue, and the other at the southeast corner of the laboratory/administration-type building (building 14). Both stacks are probably made of steel piping. A control valve building is situated near the southeast corner of building 9. The U-shaped laboratory-type building (building 11) and building 8 (previously reported as two buildings 1/) have been separately fenced. The small rectangular building north of building 11 no longer exists.

Facility C. Although building 16 resembles a reactor building, it probably does not house a reactor. This building is slightly smaller than the reactor buildings in Reactor Area I and considerably smaller than those in Reactor Area II. In [REDACTED] a stack at least 100 feet high was identified near the southeast corner of building 16, and it is connected to that building by a horizontal flue. The previously reported probable semiburied tanks 1/ are two T-shaped buildings (buildings 19 and 20) which may have been

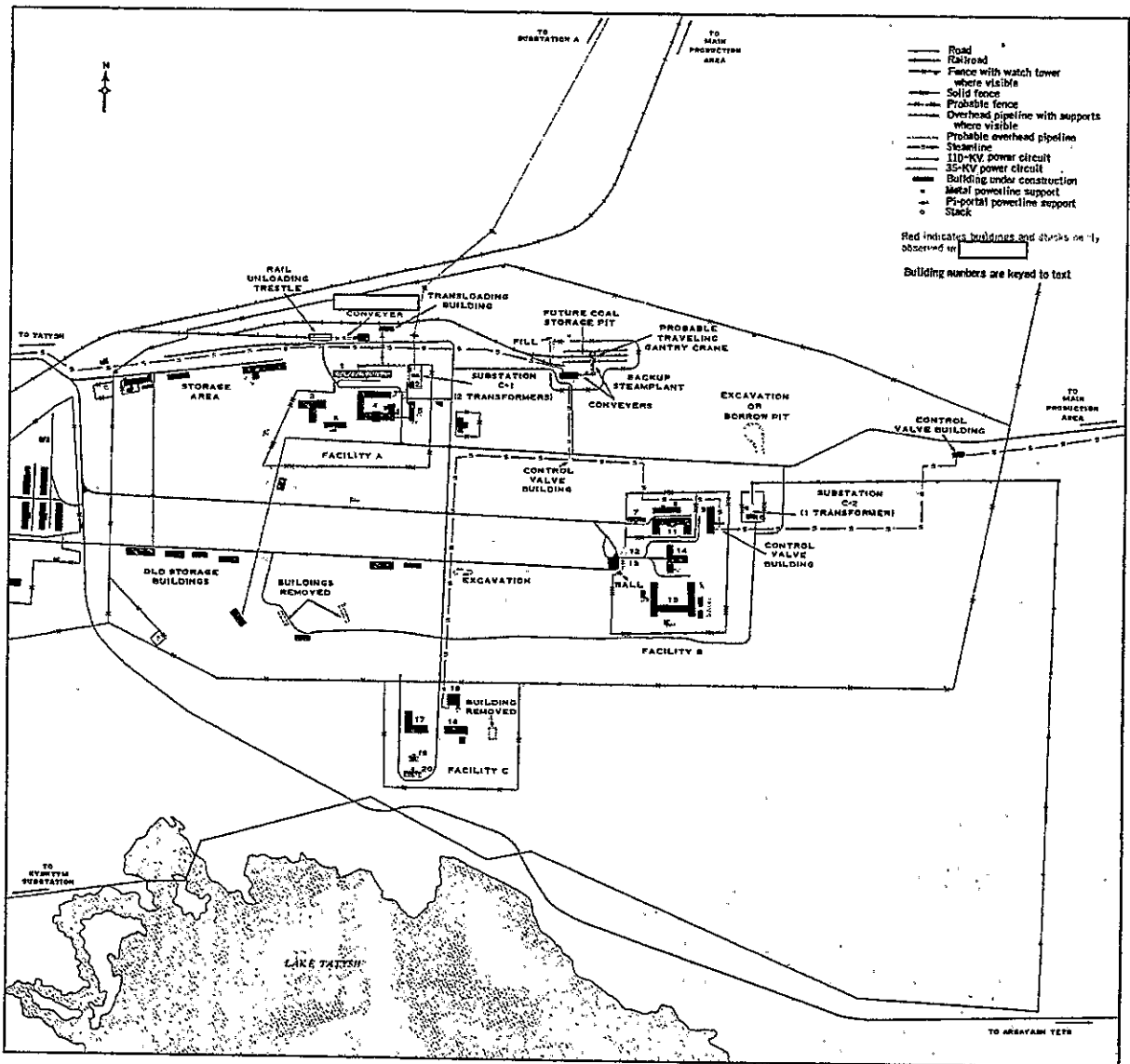

25X1

25X1

FIGURE 13. TATYSH PRODUCTION AREA.

25X1

25X1

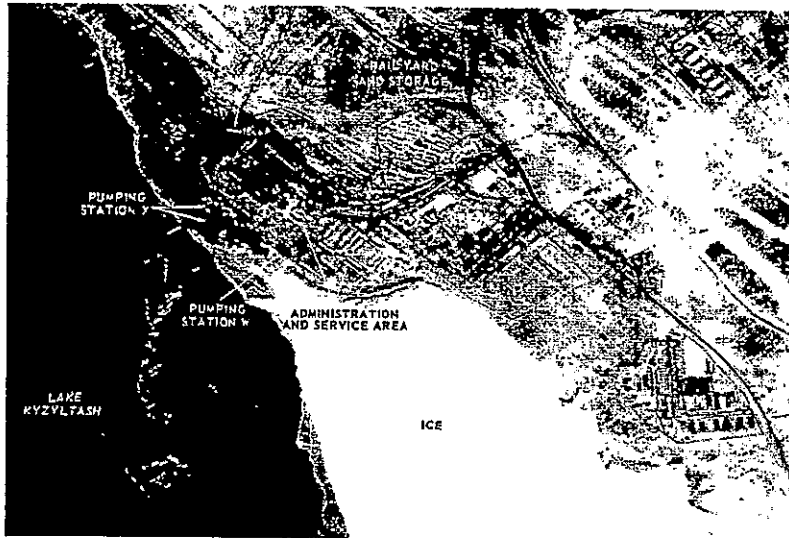

FIGURE 14. ADMINISTRATION AND SERVICE AREA.

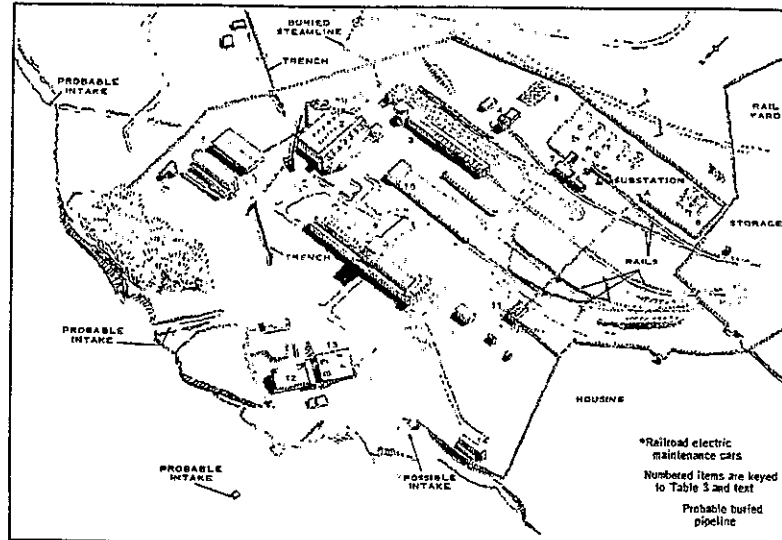

FIGURE 15. PERSPECTIVE OF EASTERN PORTION OF THE ADMINISTRATION AND SERVICE AREA.

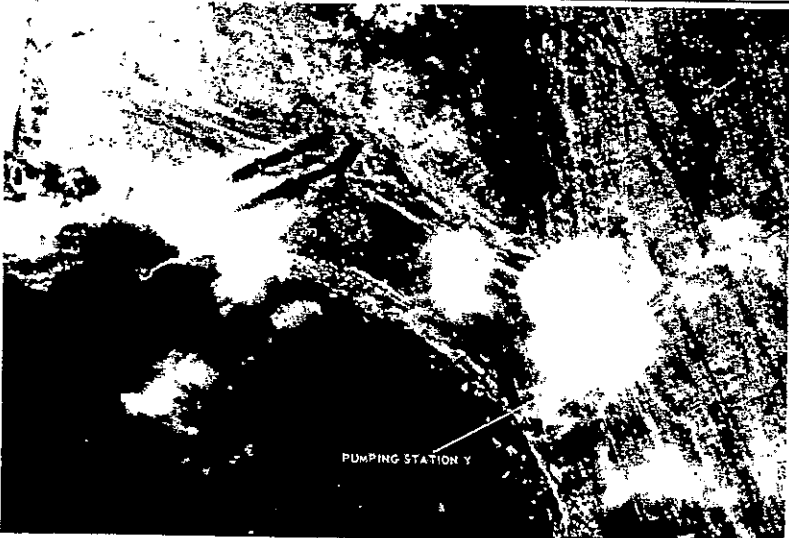

FIGURE 16. PUMPING STATION Y, MAIN PRODUCTION AREA.

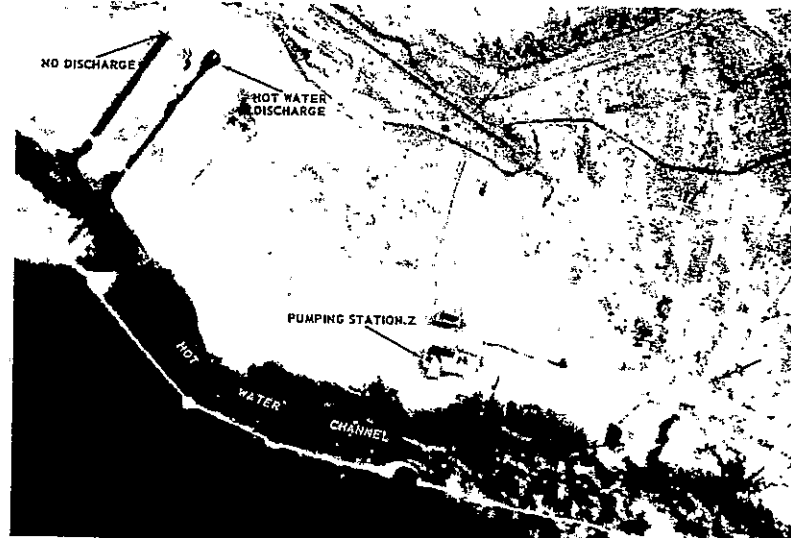

FIGURE 17. PUMPING STATION Z, MAIN PRODUCTION AREA.

25X1

25X1

25X1

under construction in [redacted] A building east of building 18 has been removed. With the exception of a steamline extending from a control valve building south of the steamplant to building 16, no other steamlines or pipelines were observed in Facility C. No hot water effluent was discernible in Lake Tatysh or in any of the other nearby lakes and ponds, and no high tension electric power facilities were visible inside the facility.

WATER TREATMENT FACILITIES

In addition to the water treatment plants in and near Reactor Areas I and II, the separately secured eastern portion of the Administration and Service Area on the southern shore of Lake Kyzyltash also contains water treatment facilities (Figures 14 and 15 and Table 3). These include two water treatment plants (items 1 and 9), a water treatment building (item 10), and Pumping Stations W and X (items 12 and 14). A steamplant (item 2) with an associated coal thawing building (item 3) and substation A are also situated in the immediate vicinity of these facilities. Previously considered as a main administration building, 1/ the largest water treatment plant (item 9) in the area is a T-shaped structure with a one-story stem and a crossbar having a narrow second story. A high tower is situated in the middle of this plant, and a small tower, two or three stories high, is located at the west end of the crossbar. The configuration of this plant differs from the configurations of the water treatment buildings observed in and near Reactor Areas I and II. A long low water treatment building (item 10) is located south of the T-shaped plant, and a head structure at the east end of the building is probably three

stories high. This building resembles Russian water softening buildings, 2/

No significant changes were noted in Pumping Stations W, Y (Figure 16), and Z (Figure 17). A covered rectangular possible reservoir (item 13) situated above ground level is visible southwest of Pumping Station X (item 12).

Three probable and one possible water intakes were visible along the southern shore of Lake Kyzyltash near the water treatment facilities (Figure 20). On the southeastern shore of the lake seven discharge points feed hot water into six open-air channels which empty into a hot water channel. In [redacted] hot water was being discharged at all points except the easternmost point, and vapor was visible over most of the hot water channel. Although the easternmost channel was not frozen at that time, no flow of water was discernible, but a large volume of water was being discharged into the adjacent channel. North of Reactor Area II hot water is carried through a probable buried pipeline extending to a stream which parallels the Techa Valley bypass canal. The flow of water through the pipelines serving the Main Production Area is shown in Figure 20.

Table 3. Facilities in the Eastern Portion of the Administration and Service Area (Item numbers are keyed to Figure 15)

Item No	Description
1	Water treatment plant
2	Steamplant
3	Coal thawing building
4	Transformer maintenance building
5	Transformer oil storage
6	110-kv switching yard in substation A
7	Control & low voltage switching building
8	35-kv switching yard in substation A
9	Water treatment plant
10	Water treatment building
11	Security building
12	Pumping station X
13	Possible reservoir
14	Pumping station W

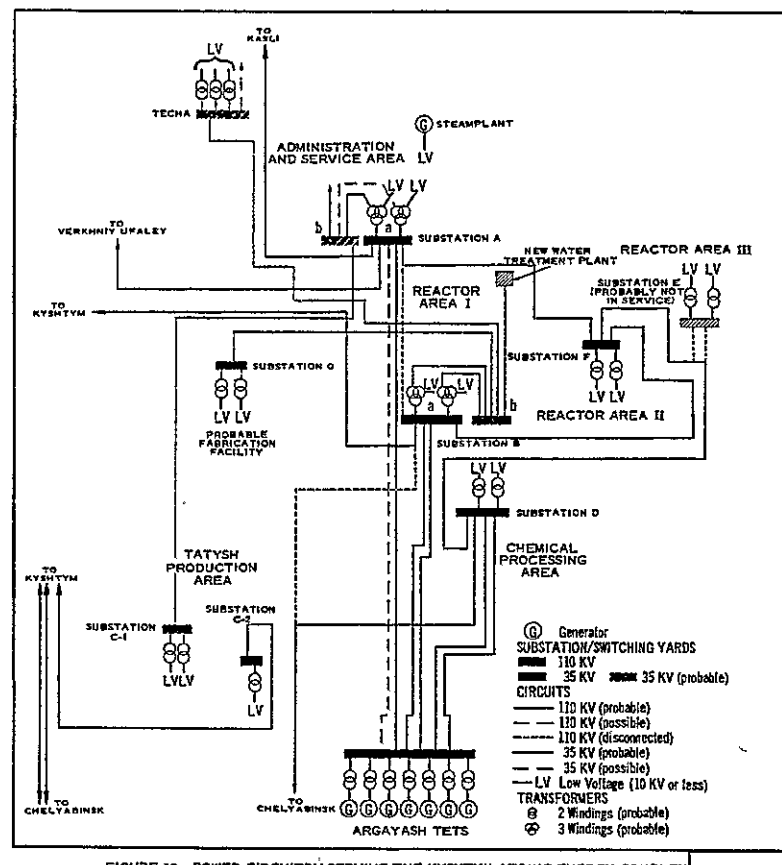

FIGURE 18. POWER CIRCUITRY SERVING THE KYSHTYM ATOMIC ENERGY COMPLEX

ELECTRIC POWER

The [redacted] photography revealed many details of electric power equipment and facilities in the Kyshtym Atomic Energy Complex for the first time. This information includes switching equipment in substations, configurations of control buildings, and powerline supports for both 110-kilovolt (kv)

and for low-voltage powerlines, probably at 35 kv. The configurations of visible powerline supports make it possible to determine whether they can carry one or two circuits. However, the quality of the [redacted] photography does not permit a firm estimate of the number of circuits which may be in service. The estimated electric power situation within the complex in [redacted] is presented in Figures 18

25X1

25X1

25X1

25X1

25X1

25X1

and 19, and an analysis of the probable situation at the substations serving the complex is given in Table 4. This estimate supersedes all those presented in previous reports on electric power within the complex.

In [] it was evident that:

1. Two 110-kv circuits which tie substation F in Reactor Area II to substations

B in Reactor Area I and D in the Chemical Processing Area probably pass through Reactor Area III without being tied into substation E in that area (Figure 8).

2. The 110-kv tie circuit between substations A and B has been disconnected from substation B and now ties substation A into substation F. This circuit originally passed through the site of the new water

treatment plant north of Reactor Area I.

3. Similarly, the 110-kv feeder powerline from Chelyabinsk to substation B has been diverted to substation D. Inasmuch as the supports for this powerline are pi-portal and single circuit, only one 110-kv circuit feeds power to the complex from the direction of Chelyabinsk.

4. At least five, possibly six, 110-kv

circuits leave Argayash TETS: one powerline with two circuits is tied to substation D; one powerline with two circuits is tied to substation B; one powerline with one, possibly two, circuits is tied to substation A. Supports for this powerline are steel lattice towers; whether they are capable of supporting one, or more likely two, circuits cannot be positively determined

Table 4. Substation Analysis, Kyshtym Atomic Energy Complex

Substation	Kilovolts (kv)	No of Outside Circuits	Est No of Switching Positions	Transformers			Transformer Maintenance Bldg	Transformer Oil Storage	Control Bldg		Remarks
				No	Est	kv			Design	Has Low-Voltage Switching	
MAIN PRODUCTION AREA											
A											
switching yard a	110	4 probable 1 possible	9	2	110/35/10 or 6		yes	6 tanks	L-shaped; 2 stories	in 1-story section at W end of main bldg	L-shaped secured area contains yards a & b; rail served; may receive power from steamplant in Admin & Service Area
switching yard b	35 (probable)	2 probable	3 (possibly 4)	--	--		--	--			
B											
switching yard a	110	4 probable	9 (possibly 10)	2	110/35/10 or 6		none	none	L-shaped; 2 stories	in 1-story section at N end of main bldg	Rail served
switching yard b	35 (probable)	3 probable	5 (possibly 6)	--	--		--	--			
D											
	110	4 probable	probably 6	2	110/10 or 6		none	none	standard USSR; 2 stories	yes	Rail served
E*											
	110	4 (probably disconnected)	possibly 4**	2	110/10 or 6		none	none	standard USSR; 2 stories	yes	Probably not in service; powerlines entering Reactor Area III from SW probably bypass substation & leave area to W; rail served
F											
	110	3 probable	5	2	110/10 or 6		none	none	standard USSR; 2 stories	yes	Rail served; surrounded by a solid fence
G											
	35	1 probable	8	2	35/10 or 6		none	none	--	yes	Not rail served; situated in Probable Fabrication Facility
TATYSH PRODUCTION AREA											
C-1											
	35 (probable)	1 probable	4 (possibly 5)	2	35/10 or 6		none	none	1-story rectangle	yes	Not rail served
C-2											
	110	1 probable	Indeterminable; probably 1	1	110/10 or 6		none	none	1-story rectangle	yes	Not rail served; surrounded by a solid fence; near NE corner of Facility B rather than inside facility as previously reported 1/
TOWN OF TECHA											
Techa											
	35	1 (possibly 2)	5 (possibly 6)	3	35/10 or 6		yes	4 tanks	standard USSR; 2 stories	yes	Possibly rail served

* The operational status of substation E cannot be determined. The SE transformer has switching position supports; no switching equipment for the NW transformer is clearly visible, and supports for its switching position cannot be identified.

** Some equipment appears to have been removed.

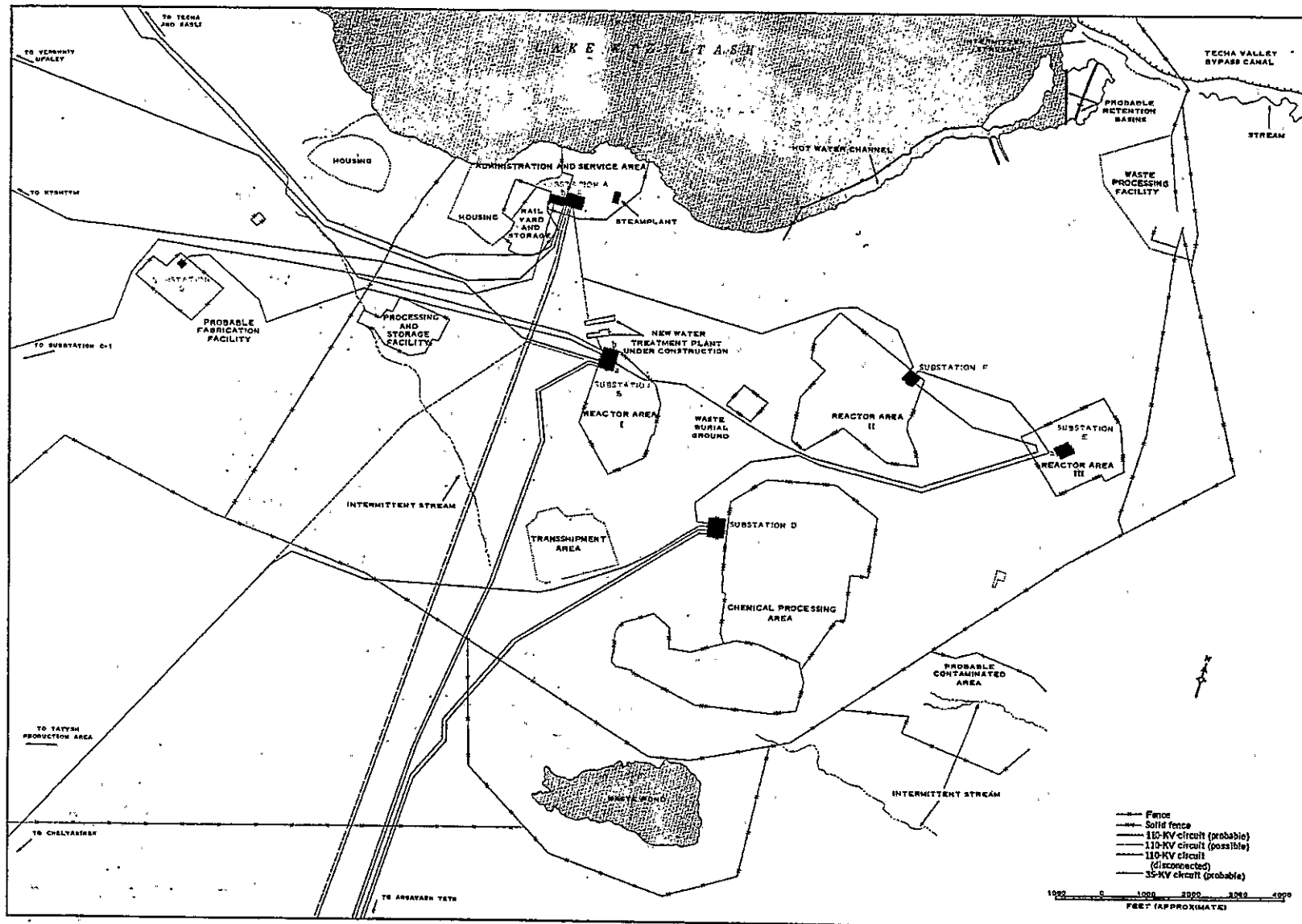

FIGURE 19. POWER CIRCUITS SERVING THE MAIN PRODUCTION AREA.

25X1

25X1

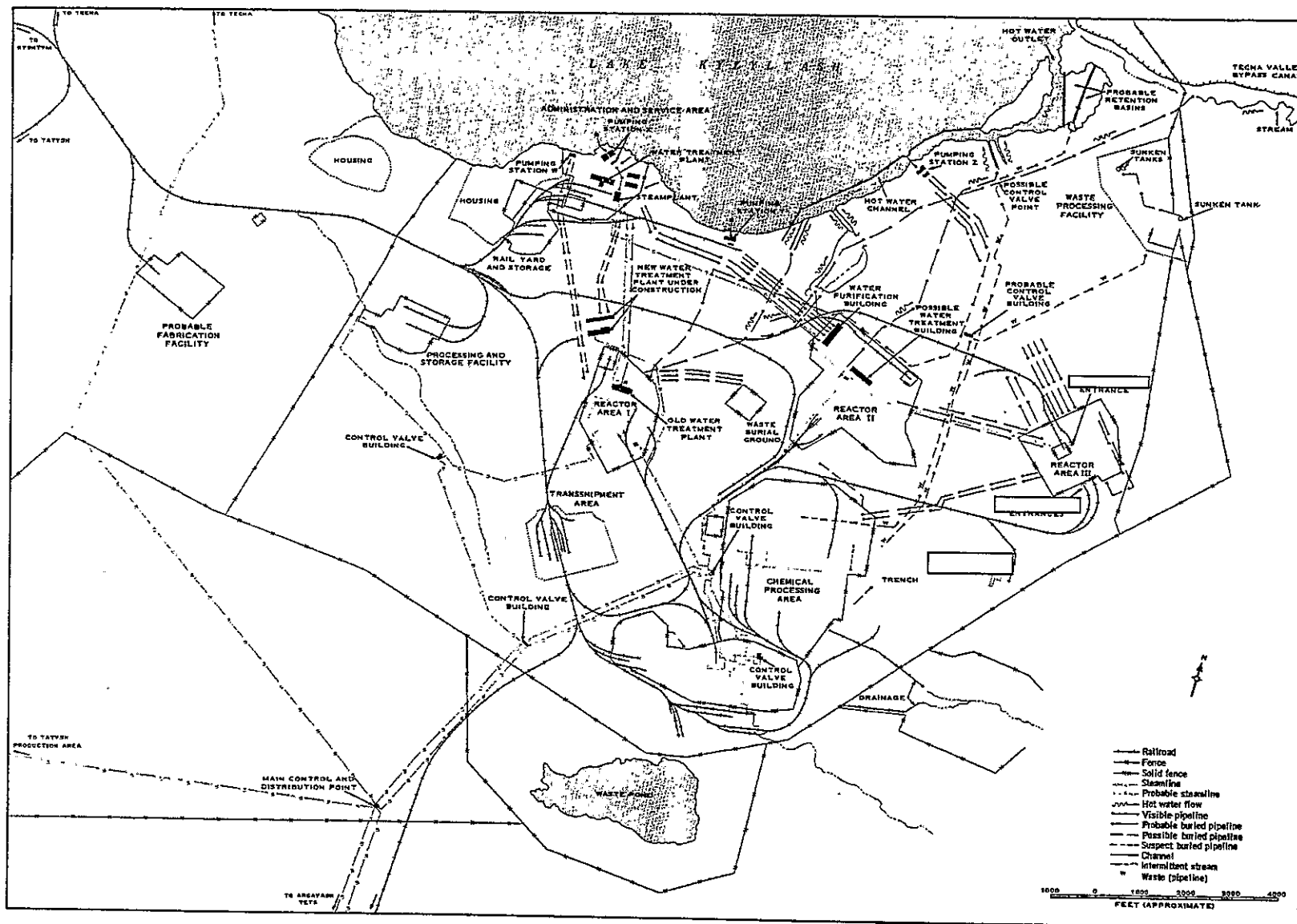

FIGURE 20. WATER, STEAM, AND TRANSPORTATION FACILITIES IN THE MAIN PRODUCTION AREA.

25X1

25X1

25X1

25X1

25X1

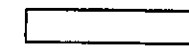

from the photography.

5. At three points 110-kv powerlines apparently cross each other. Although this is not common electrical engineering practice, the placing, supports, and relative heights of the powerlines at these points preclude any other interpretation.

6. Substation C-1 in the Tatysh Production Area is fed power, probably at 35 kv and not 110-kv power as previously

estimated 1/, from switching yard b in substation A.

7. Substation C-2 in the Tatysh Production Area receives 110-kv power from the direction of Kyshtym over a one-circuit powerline, not over two circuits as previously reported. 1/

8. Newly identified 35-kv substation G serves the Probable Fabrication Facility and receives power from switching yard b

in substation B.

9. The substation in Techa now receives 35-kv power (instead of 110-kv) from switching yard b in substation B. The 110-kv single-circuit powerline from switching yard a in substation A to Kasli bypasses Techa between the town and Lake Kyzyltash.

10. Railroad electric power maintenance car(s) were standing near the two

transformers in substation A, indicating electrical maintenance repairs or possible installation of equipment.

11. Substations A and B are now observed to have both 110-kv switching equipment (switching yard a) and probably 35-kv switching equipment (switching yard b).

REFERENCES

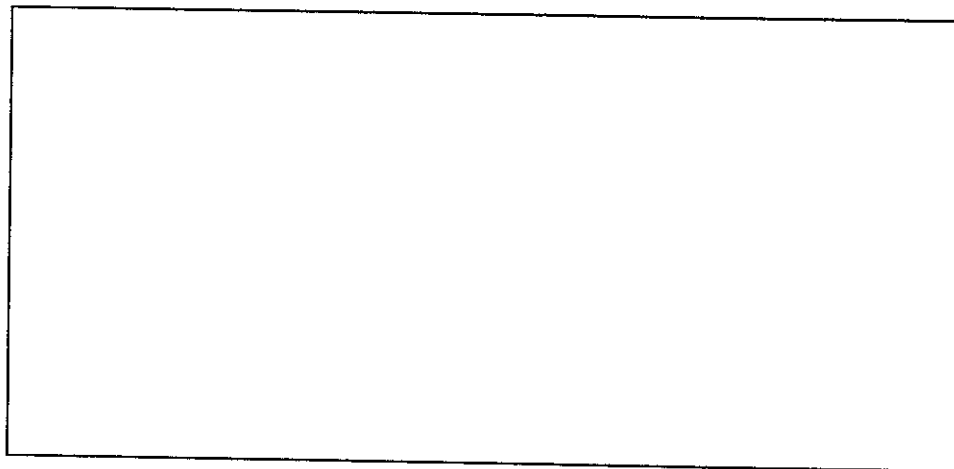

MAPS OR CHARTS

ACIC. US Air Target Chart, Series 200, Sheet 0164-2A, 1st ed, Oct 59, scale 1:200,000 (SECRET)

ACIC. US Air Target Chart, Series 200, Sheet 0164-3A, 2d ed, Jan 60, scale 1:200,000 (SECRET)

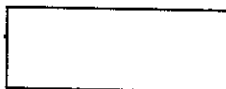

25X1

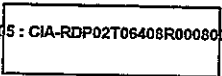
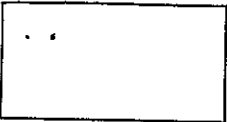

NPIC/R-568/64

25X1

REFERENCES (Continued)

DOCUMENTS

25X1

1. NPIC. R-248/63, Reactor Area I, Kyshtym Atomic Energy Complex, USSR, [redacted] Oct 63 (TOP SECRET)

25X1

25X1

NPIC. R-281/63, Reactor Area II, Kyshtym Atomic Energy Complex, USSR, [redacted] Oct 63 (TOP SECRET)

25X1

25X1

NPIC. R-299/63, Reactor Area III, Kyshtym Atomic Energy Complex, USSR, [redacted] Nov 63 (TOP SECRET)

25X1

25X1

NPIC. R-352/63, Tatysh Production Area, Kyshtym Atomic Energy Complex, USSR, [redacted] Dec 63 (TOP SECRET)

25X1

25X1

NPIC. R-62/64, Argayash Thermal Electric Power Plant, Kyshtym Atomic Energy Complex, USSR, [redacted] Jan 64 (TOP SECRET)

25X1

25X1

NPIC. R-74/64, Chemical Processing Area, Kyshtym Atomic Energy Complex, USSR, [redacted] Feb 64 (TOP SECRET)

25X1

25X1

NPIC. R-188/64, Auxiliary Facilities, Utilities, and Transportation Networks, Kyshtym Atomic Energy Complex, USSR, [redacted] Mar 64 (TOP SECRET)

25X1

2. Main, Charles T. Industrial Water Supply in the USSR, Boston, Mass., and Charlotte, N. C., 1 Nov 61 (UNCLASSIFIED)

REQUIREMENT

CIA. C-SI4-81,139

NPIC PROJECT

N-271/64

APPENDIX A

25X1

25X1

[redacted] photography of [redacted] revealed that since [redacted] construction has progressed on the chemical processing building (building 27) in Chemical Separation Plant No 3 and that there were no changes in hot water discharge in the complex.

25X1

~~TOP SECRET~~



25X1
25X1

~~TOP SECRET~~

~~TOP SECRET~~